

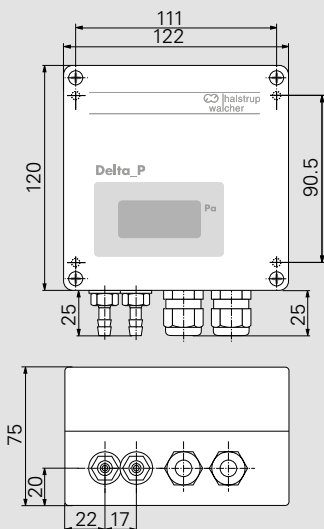

Features

- Differential pressure transmitter with linear curve for air-conditioning applications
- Also available as a two-wire system ("PIZ" model)
- Also for \pm measurement ranges and asymmetric measurement ranges
- With optional LCD

PU/PI with display



PU/PI without display

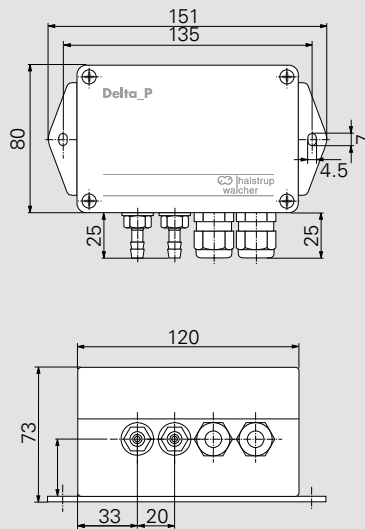

PIZ with display

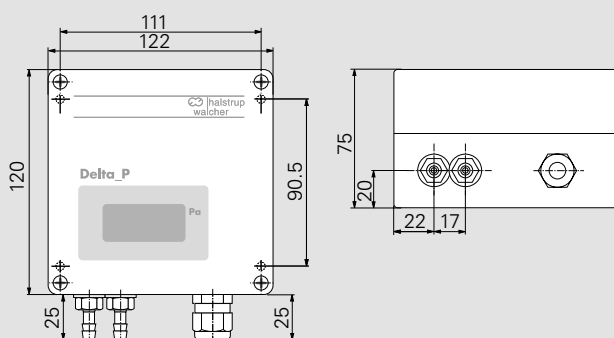

Measurement ranges (also \pm measurement ranges) others available upon request	50/100/250/500 Pa 1/2.5/5/10/20/50/100 kPa
Margin of error (0.3 Pa margin of error for the reference)	$\pm 0.2\% \text{ FS}^{1)}$ only for measurement ranges $\geq 250 \text{ Pa}$ and $\leq 50 \text{ kPa}$ $\pm 0.5\% \text{ FS}^{1)}$, $\pm 1\% \text{ FS}$
Temperature coefficient span	0.04 %FS /K (10..60 °C)
Temperature coefficient zero point	0.04 %FS /K (10..60 °C)
Zero point stability	0.5 % FS/year
Overload capacity	10 x for measurement ranges $\leq 20 \text{ kPa}$ 2 x for measurement ranges $> 20 \text{ kPa}$
Medium	air, all non-aggressive gases
Max. system pressure	10 kPa for measurement ranges $\leq 10 \text{ kPa}$ max. nominal pressure of the sensor for measurement ranges above 10 kPa
Sensor response time	20 ms
Operating temperature	10..60 °C
Storage temperature	-10..70 °C
Power consumption	PU/PI: approx. 3 VA PIZ: max. 0.6 VA
Weight	approx. 0.8 kg
Cable glands others available upon request	PU/PI: 2xPG 7 PIZ: 1xPG 7
Pressure ports	for tubing NW 6 mm
Protection class	IP65
Certificates	CE

Model	Output	A
PU	0..10 V ($R_L \geq 2 \text{ k}\Omega$)	U
PI	0..20 mA ($R_L \leq 500 \Omega$)	I0
PI	4..20 mA ($R_L \leq 500 \Omega$)	I4
PIZ	4..20 mA two-wire ($R_L \leq 50 [U_B (V) - 10 (V)] \Omega$)	IZ

Measurement range	B	Margin of error	C
e.g. 0..100 Pa, 0..60 mbar, $\pm 110 \text{ mmHg}$ (etc.)		$\pm 0.2\% \text{ FS}^{1)}$ only for measurement ranges $\geq 250 \text{ Pa}$ and $\leq 50 \text{ kPa}$	02
		$\pm 0.5\% \text{ FS}^{1)}$	05
		$\pm 1\% \text{ FS}$	1

¹⁾ not for PIZ with \pm measurement ranges

Supply voltage	D
24 VDC, +20 % / -15 % ²⁾	24D
24 VAC, +6 % / -15 % (50/60 Hz) ²⁾	24A
115 VAC, +6 % / -15 % (50/60 Hz) ²⁾	115
230 VAC, +6 % / -15 % (50/60 Hz) ²⁾	230
10..32 VDC (two-wire system)	PIZ

²⁾ not for PIZ









Time constant	E	LCD	F
none	0	none	0
1 s	1	3 ½ digit (see foto)	3
2 s	2	4 ½ digit	4
5 s	5	(only for PU/PI)	

Order code	A	B	C	D	E	F
P	-	-	-	-	-	-

MEASUREMENT OF DIFFERENTIAL PRESSURE

Measurement of differential pressure is useful in a broad range of applications. It is used in ventilation and air-conditioning technology but also in many areas of air handling process technology. The next pages show a number of these. You can find more information about our pressure sensor technology on p.6.

halstrup-walcher offers a wide range of products for stationary measurement of differential pressure:

Product	PUC24	PUC28(K)	P26	P34	P29	PU/PI/PIZ	PS27	REG21
Details on	p. 14	p. 15	p. 16	p. 17	p. 18	p. 19	p. 20	p. 21
								
Application	Process monitoring for clean-rooms (Pa, °C, % rH), with stainless steel front	Process monitoring panel aluminium, anodised (optional: with calibration port) (Pa, °C, % rH)	High precision, freely scalable pressure transmitter for critical applications	Measuring transmitter with very small dimensions – ideal for the control cabinet	High precision, freely scalable pressure transmitter for natural gas	For standard applications. PIZ: in two wire technology	A basic sensor for simple applications	Measurement and regulation of pressure
Housing installation	Installed in wall (panel)	Mounted on a wall/top-hat rail						Rack
Max. measurement range	± 250 Pa	± 100 kPa	0.. 100 kPa		± 100 kPa			
Min. measurement range	± 100 Pa	± 10 Pa	0.. 250 Pa		± 50 Pa			
Margin of error (0.3 Pa margin of error for the reference)	± 0.5 % FS ¹⁾ (standard)	± 0.2 % FS ¹⁾ (optional) ± 0.5 % FS (standard)	± 0.2 % FS ¹⁾ (optional)	± 0.2 % FS ¹⁾ (optional) ± 0.5 % FS (standard)	± 0.2 % FS ²⁾ ± 0.5 % FS ± 1 % FS	± 2 % (≥ 100 Pa) or ± 3 % (for 50 Pa) of the set value	± 0.5 % FS ± 1 % FS	
Square-root (volume flow)	-	-	✓	✓ ³⁾	✓	-	-	-
Display	✓	✓	optional	-	optional	optional	optional	✓

¹⁾ for measurement ranges ≤ 50 kPa

²⁾ for measurement ranges ≥ 250 Pa and ≤ 50 kPa

³⁾ optionally with stat. pressure sensor and temperature analogue output for compensation

ACCESSORIES

Certificates (see p.42)

DAkkS calibration certificate (German)
DAkkS calibration certificate (English)
ISO factory calibration certificate

Order no.

9601.0003
9601.0004
9601.0002

User software

You can set the parameters for our instruments or monitor and record measurements using a PC via a USB or RS232 interface. These features are supported by our free user software. This also allows you to transfer your settings to other devices by saving and reusing them.

Connecting components

Silicone tubing ID 5 mm, OD 9 mm, red (please state length required) 9601.0160
Silicone tubing ID 5 mm, OD 9 mm, blue (please state length required) 9601.0161
Norpren tubing (please state length required) 9061.0132
Y-piece for tubing 9601.0171

Our user software is compatible with the following pressure transmitters: PUC24, PUC28(K), P26, P34 and P29.

You can download the file here:

www.halstrup-walcher.de/en/software

Pressure ports

We can supply a wide range of customer-specific pressure ports, e.g. various cutting ring couplings or hose connectors.